

NUSCO

Porte e infissi da tre generazioni



Gentile partner,

la Nusco SpA rappresenta una delle delle più solide realtà italiane nell'industria dei serramenti.

Dal 1968, anno di fondazione dell'azienda ad opera di Mario Nusco, offriamo una gamma prodotti che ha saputo adeguarsi alle mode e allo scorrere del tempo.

Negli anni, abbiamo arricchito la nostra offerta, che oggi, oltre alle porte, presenta una gamma completa di finestre in legno, legno alluminio, alluminio e pvc, oltre a persiane e grate di sicurezza, Scegliere Nusco vuol dire affidarsi ad un'azienda che può vantare una storia di tre generazioni, a riprova della nostra solidità e affidabilità.

Ci auguriamo che possiate trovare nel nostro catalogo prodotti che possano emozionarvi e rispecchiare l'amore e la passione che da sempre mettiamo nel nostro lavoro.

Luigi Nusco



La qualità Made In Italy di porte, finestre, grate e persiane Nusco sono riconosciute a livello mondiale, grazie alla dimensione internazionale consolidata dall'azienda nel corso degli anni.



made in italy

storia e valori

La nostra mission è creare ambienti emozionanti e accoglienti per migliorare la qualità della vita.

Da tre generazioni, Nusco è laboratorio della sartorialità, in cui la passione per il lavoro e la cura dei dettagli sono valori imprescindibili per la creazione di porte, infissi e sistemi "su misura"

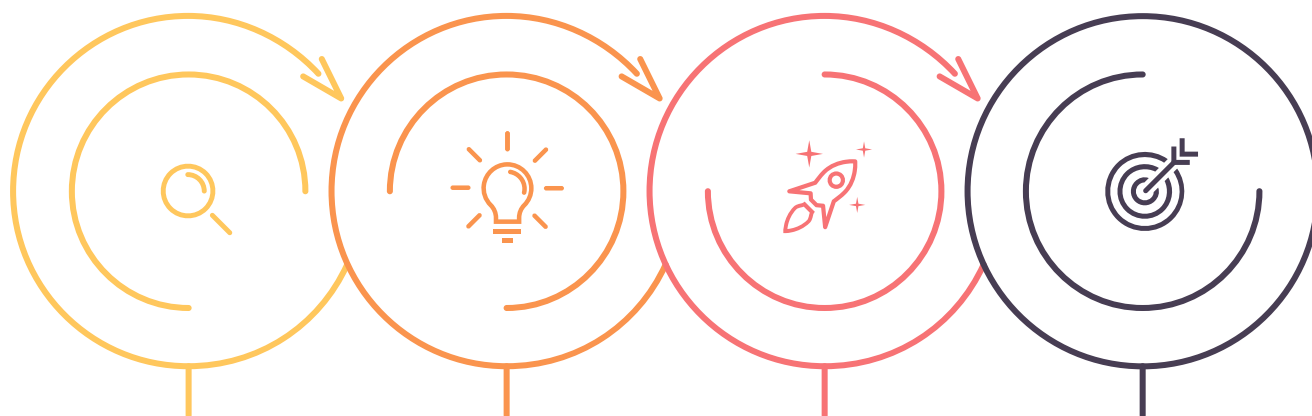



rispetto
fiducia
crescita personale

creatività
innovazione
sartorialità

affidabilità
trasparenza
serietà

soddisfazione del cliente
professionalità
cura

2011
Nascita Nusco
S.p.A. e avvio
progetto
franchising

2012
Ampliamento
linea produttiva -
infissi in PVC

2015
Nuova linea
produttiva -persiane
e grate in ferro
Iron

2019
Ampliamento
rete franchising
Nusco store
Roma

2020
Nuova linea
infissi alluminio

2021
Quotazione sul
mercato Aim
Borsa Italiana

- Azerbaijan
- Romania
- Kuwait

In continua espansione





nusco nel mondo

Un team di persone qualificate, serie e affidabili vi accoglierà nei nostri nuovissimi showrooms di porte, infissi e blindati.

Partecipiamo alle manifestazioni italiane ed estere più importanti al mondo, siamo presenti in tutta Italia con franchising e rivenditori.

Abbiamo accumulato un'esperienza tale da permetterci di essere tra i migliori produttori di porte da interno, infissi, blindati, persiane e grate di sicurezza.

I nostri prodotti rappresentano un passaggio generazionale tra la continuità e il design moderno, per soddisfare qualsiasi tipo di gusto.

Siamo pronti a ricevere le sfide del futuro.



LA PRIMA INDUSTRIA DI PORTE
E FINESTRE QUOTATA IN BORSA
CON OLTRE 50 FRANCHISING





Porte

Pantografate	
linea Artwork	16
linea Quadra	22
linea Mirror ed Elegance	28
linea Fashion	34
linea Incise	40
linea Tirreno	46
Laminate	
linea Texture	52
linea Sublime Soft	58
linea Ngl	64
linea Ideal	70
linea Vision	76
linea Innova	82
linea Rever	88
	92
Massello	
linea Platinum	104
Lavorazioni speciali	
Piego simmetrica / asimmetrica / rototraslante	110
Complanare	111
Scorrevole Magic	114
Filomuro	
linea Filomuro Nusco	118
Vetri e decorazioni	124
Maniglie	126
Alluminio	
linea Lux	128
Blindati	134

Finestre, persiane e grate

Pvc	142
Pro 72	
Power9000	
Legno	148
Cosmo68	
Legno Alluminio	
Cosmo68 Flat	154
Sintesy	160
Ferro	
Persiane e Grate Iron	166
Alluminio	172
Infissi	
Persiane Oscuria	



collezioni



PORTE



Un viaggio nella mente con l'ausilio di linee che solcano il legno vivo, incrociandosi e allontanandosi disegnano confini immaginari dai tratti sobri e decisi, contaminati da riflessi di luce ed effetti speciali.

Artwork nasce dal desiderio di creare un prodotto innovativo nella lavorazione ed elegante al tempo stesso.

La lavorazione si ottiene con frese meccaniche che accarezzano il pannello sottoposto successivamente a laccatura dal nostro team di esperti verniciatori.

Artwork è il mondo in cui viviamo, è l'espressione dei 5 sensi.

Artwork è l'arte in una porta.

artwork

Suggerimenti senza confini





artwork model



ellisse



astratta



dinamica



sistema



simply



incanto



double



sirio



linea



twist



polar



sfumata 01



sfumata 02



sfumata 03

artwork colori

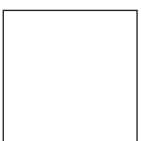

Bianco

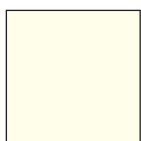

Avorio



Tortora



Grigio

Altri RAL a richiesta

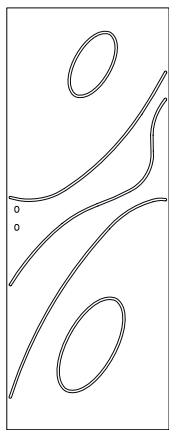

ELLISSE

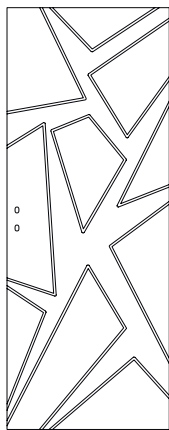

ASTRATTA

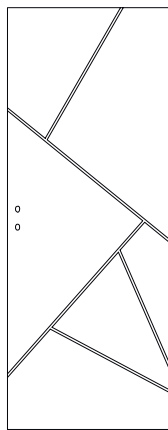

DINAMICA

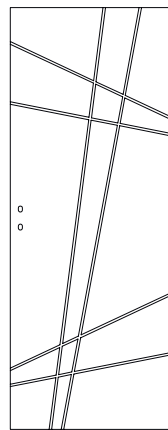

SISTEMA

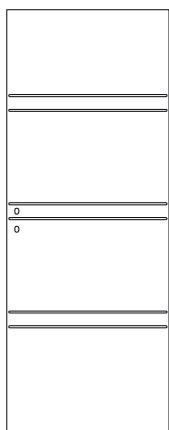

SIMPLY

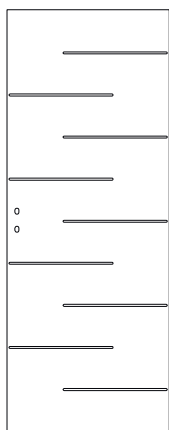

INCANTO

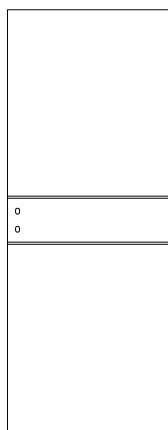

DOUBLE

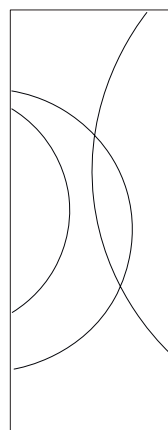

SIRIO

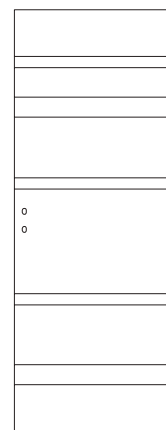

LINEA

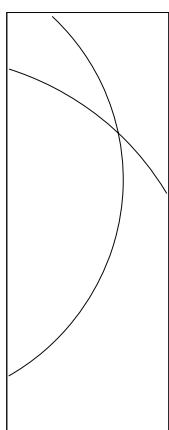

TWIST

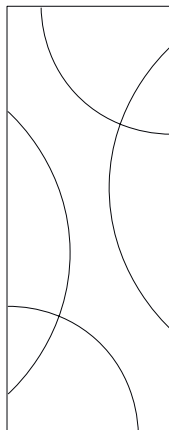

POLAR

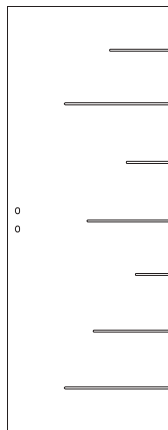

SFUMATA01

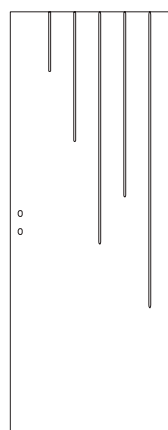

SFUMATA02

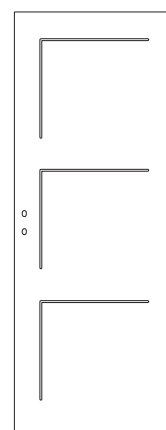

SFUMATA03

artwork technic

Di serie, telaio squadrato in listellare di abete e coprifili LSB [acquarius]. Anta senza battuta, serratura magnetica e 3 cerniere a scomparsa regolabili di serie.

Cerniera a scomparsa

LSB

listellare



QUADRA

soluzioni innovative
dal design moderno

Contemporaneità per ogni ambiente, nella nuova collezione Quadra Nusco. Le finiture laccate si abbinano alla linearità degli elementi, per un design minimal ma deciso. Elegante elemento d'arredo e design, si adatta con stile e versatilità agli ambienti domestici.







quadra model



1B



2B



3B



4B

quadra colori

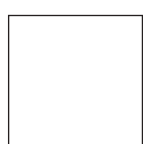

laccato bianco puro RAL 9003

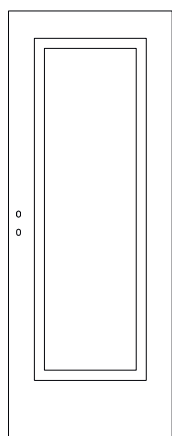

1B

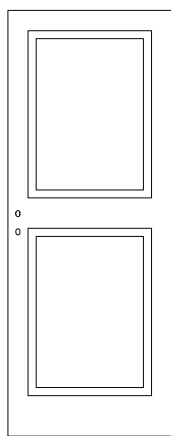

2B

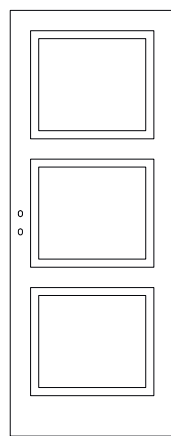

3B

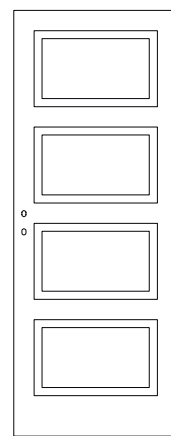

4B

quadra technic

Di serie, telaio squadrato in listellare di abete e coprifili LSB (acquarius). Anta senza battuta, serratura magnetica e 3 cerniere a scomparsa regolabili di serie.

Cerniera a scomparsa
regolabili

Serratura magnetica

LSB

listellare

MIRROR ED ELEGANCE

suggerzioni senza confini

Eleganti giochi di vetro e fodere, dal design minimal,
che arredano gli ambienti domestici con stile.

Nascono così i nuovi modelli Mirror ed Elegance.







mirror ed elegance model



artwork mirror 200



artwork elegance 80



artwork elegance 200



artwork elegance 40-110

mirror ed elegance colori

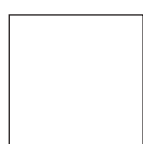

Bianco

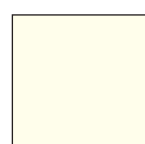

Avorio



Tortora



Grigio

Altri RAL a richiesta

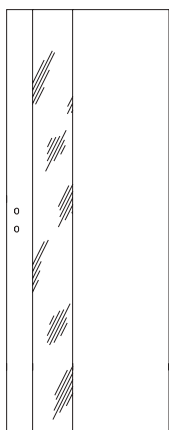

artwork mirror 200

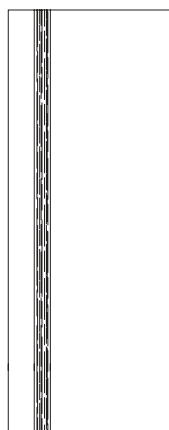

artwork elegance 80

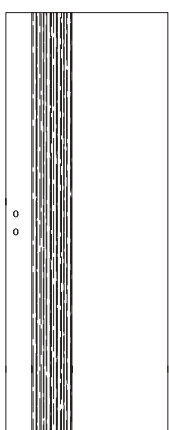

artwork elegance 200

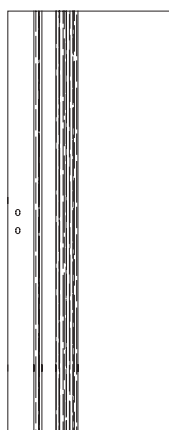

artwork elegance 40-110

mirror ed elegance technic

Di serie, telaio squadrato in listellare di abete e coprifili LSB.

Anta senza battuta, serratura magnetica e 3 cerniere a scomparsa regolabili di serie.

Disponibile nei colori bianco, avorio, tortora, grigio e altri Ral a richiesta

cerniera a scomparsa



vetro laccato (mirror)

LSB

listellare

LINEA FASHION

lo stile prende forma

Design e stile si fondono nella linea Fashion, nata per rispondere alle esigenze d'arredo per ambienti moderni e luminosi.







linea fashion model



favolosa*



fashion 01



incantevole



fashion heritage*

linea fashion colori



laccato
bianco



Frassino
bianco



Dress
chiaro



Palissandro
white



Olmo



Grey



Palissandro
blue

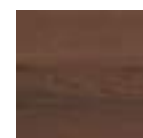

Noce
greenwood

*Favolosa e fashion heritage realizzabili solo in laccato bianco

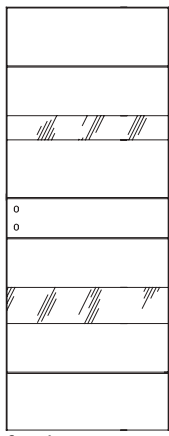

favolosa

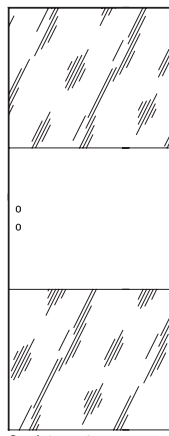

fashion 01

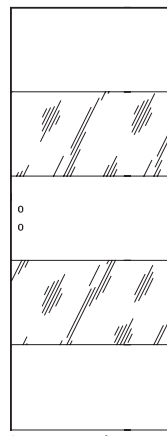

incantevole

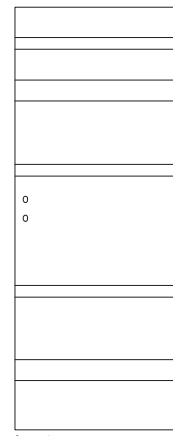

heritage

linea fashion technic

Vetri laccati bifacciali simmetrici su entrambi i lati della porta.
Telaio e coprifilo LSB da 70/100.
Anta con battuta in alluminio, per una maggiore robustezza ed un forte impatto estetico e di design.
Serratura magnetica e 3 cerniere a scomparsa regolabili di serie.

cerniera a scomparsa

anta con battuta in alluminio

**vetro laccato bifacciale
su entrambi i lati**



PANTOGRAFATE e INCISE

personalità e versatilità

Nuove nelle linee, dalla semplice pannellatura in fibra di legno, nascono le porte laccate e incise. Rigore, decisione e una straordinaria varietà di forme, per pannelli che disegnano superfici solide. Disponibili su richiesta in un'ampia gamma di colori, queste porte contribuiscono a dare un tocco di personalità anche alle case di maggior prestigio, adattandosi agli stili più svariati.





pantografate e incise model



ovale



mediterraneo 2PB



3PB



inciso 01



inciso 02

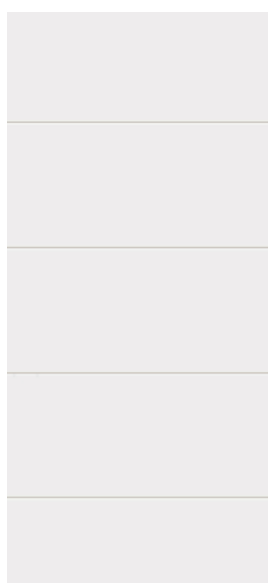

inciso 05



nt



1vg

pantografate e incise colori

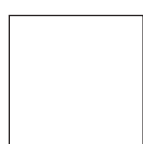

laccato bianco puro RAL 9003

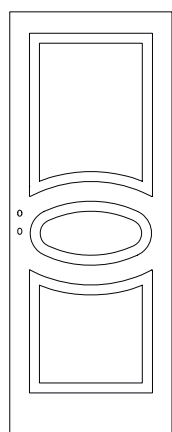

OVALE

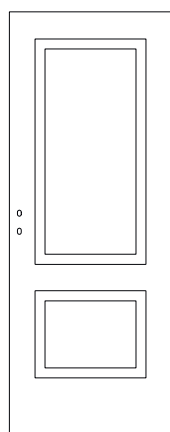

MEDITERRANEO 2PB

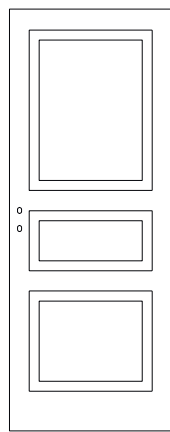

3PB

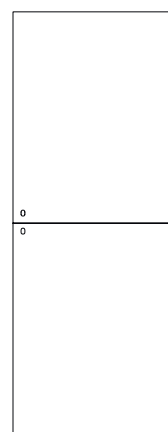

INCISO 01

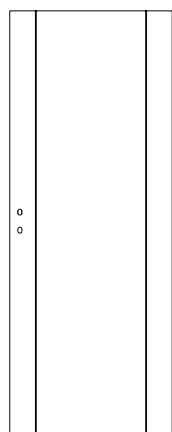

INCISO 02

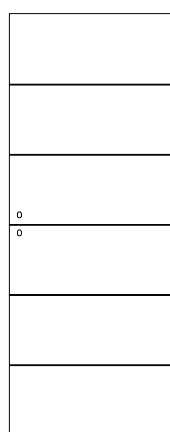

INCISO 05

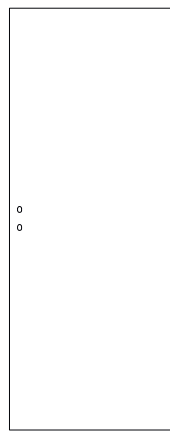

NT

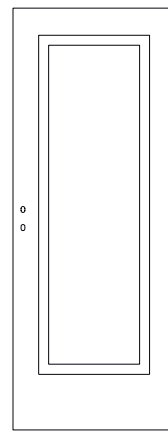

1VG

pantografate e incise

technic

Mediterraneo 2pb, 3pb, ovale e classic 4B: di seie, telaio sqadrato i listellare di abete e coprifili ACQARIUS (LSB).

Anta senza battuta, segnatura magnetica e cerniere a scomparsa regolabili. 1VG, Nt, Inciso 01, 02 e 05: di serie, telaio sqadrato in listellare di abete e coprifili multistrato piatti in listellare di abete. Anta senza battuta, segnatura magnetica e cerniere a scomparsa regolabili.

serratura magnetica

cerniera a scomparsa regolabili
(med 2pb, 3pb e ovale)

LSB

listellare



LINEA TIRRENO

qualità e personalità

I modelli CAPRI ed ISCHIA, con stipite e coprofilo in legno abete, contribuiscono a dare un tocco di qualità e personalità agli ambienti domestici.





tirreno model



capri



ischia

pantografate e incise colori

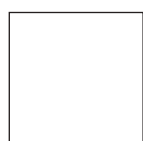

laccato bianco puro RAL 9003

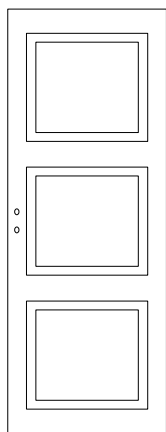

CAPRI

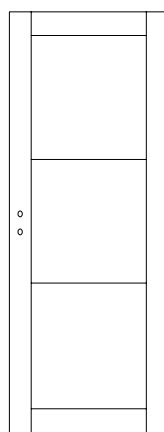

ISCHIA

tirreno

technic

TIRRENO è disponibile nelle versioni battente e scorrevole a scomparsa, nelle misure 60/70/80/90 con telaio 10,7.

Pantografata in legno;

Anta con battuta e cerniere anuba;

Colore bianco ral 9003;

Telaio in legno;

Coprifilo in legno 7|9;

Serratura meccanica;

Reversibile.



cerniera anuba



TEXTURE

innovazione
e stile moderno

Dalla ricerca di Nusco SpA nasce una linea dal design semplice e dalle superfici lisce e delicate, caratterizzata da un forte coinvolgimento sensoriale, grazie alle proprietà dei materiali ed alle particolari texture, piacevoli al tatto e alla vista.

La speciale lavorazione e l'uniformità delle finiture donano resistenza e solidità per rendere duratura sia la piacevolezza estetica che la consistenza della porta.





texture model



texture



texture 01*



texture 02*



texture 03*



texture 04*



texture 05*



texture 06*



1VG

texture colori

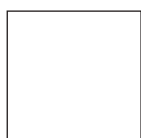

laminato bianco



Frassino bianco



Dress chiaro



Palissandro white



Olmo



Grey



Palissandro blue

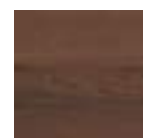

Noce greenwood

*non disponibile nelle essenze Dress chiaro e Grey

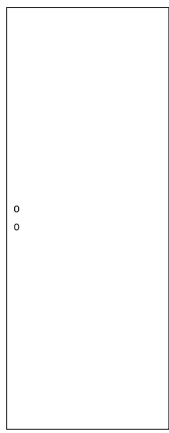

TT

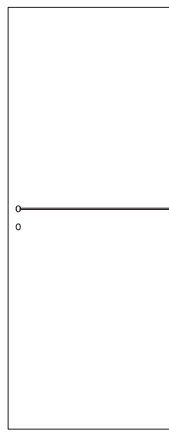

TEXTURE 01

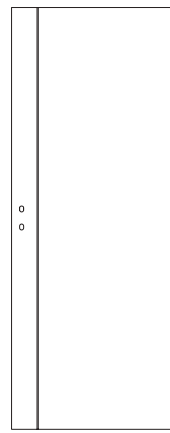

TEXTURE 02

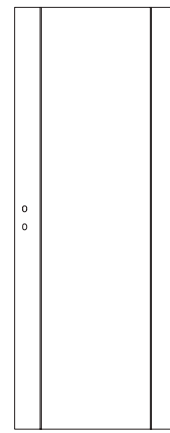

TEXTURE 03

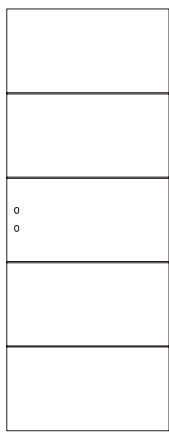

TEXTURE 04

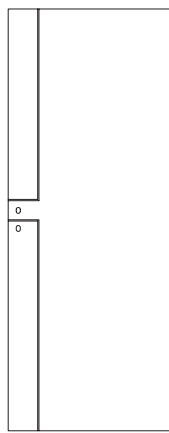

TEXTURE 05

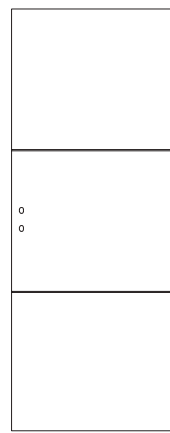

TEXTURE 06

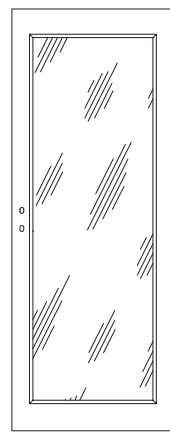

1VG

texture technic

Anta senza battuta e serratura magnetica di serie. Telaio e coprifili Acquarius (Lsb) su tutte le essenze, ad eccezione della laminatino bianco. Disponibile nelle versioni a battente, scorrevole a scomparsa, scorrevole a parete, piego.

Il telaio Acquarius è resistente all'acqua.

Realizzato al 100% in sfogliato di pioppo, per garantire leggerezza ed alte prestazioni, è costituito da grandi strand orientati, che ne assicurano un'ottima stabilità.

La struttura esterna è realizzata con sottili particelle di legno, per ottenere una superficie liscia e dura, adatta alla copertura con carta sottile. La resina MDI senza formaldeide, utilizzata per l'incollaggio, garantisce buone prestazioni in ambienti umidi.

Texture laminatino bianco disponibile solo nella versione a pannello e 1vg, con cerniere a scomparsa di serie. Telaio squadrato sandwich con coprifili in mdf da 7 e da 10 cm.

telaio acquarius



telaio squadrato sandwich solo per essenza laminato bianco

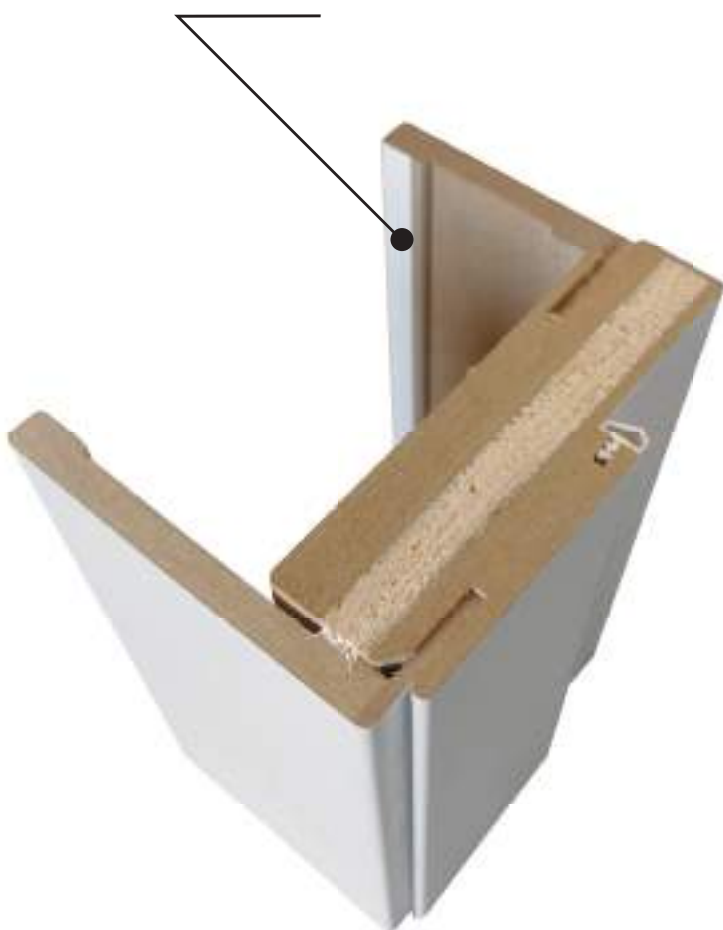

Serratura magnetica



SUBLIME SOFT

tocco elegante
e moderno

Nata dalla costante ricerca di soluzioni che uniscano estetica, funzionalità e qualità.

La versatilità dello stile della finitura SOFT è studiata per adattarsi perfettamente a una vasta gamma di contesti e stili di design, offrendo un tocco elegante e moderno agli ambienti.







sublime soft model



sublime soft

sublime soft colori



bianco



blu



tortora
chiaro

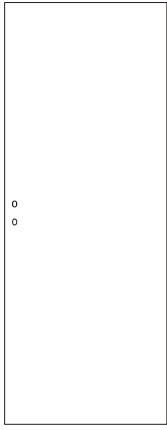

SUBLIME SOFT

sublime soft technic

CARATTERISTICHE TECNICHE

- Telaio in legno listellare
- Coprifilo in MDF 7/10
- Cerniere a scomparsa
- Serratura magnetica
- Reversibile
- Disponibile anche nella versione in vetro Ideal 04



coprifilo MDF

listellare

Serratura magnetica





NGL

Essenzialità e raffinatezza

Linee sinuose intarsiano la porta senza mai incontrarsi,
si sfiorano ma non si toccano.

Gli inserti in alluminio lucido esaltano i colori del pannello.

La linea NGL dà vita a un nuovo concept di essenzialità rivolto
a un pubblico dal gusto raffinato.





ngl model



ngl 01



ngl 02



ngl 03



ngl 04

ngl colori



Frassino bianco



Palissandro white



Olmo



Palissandro blue

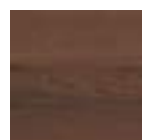

Noce greenwood

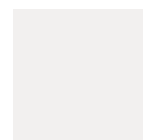

Laminatino bianco

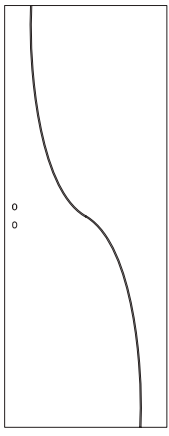

NGL 01

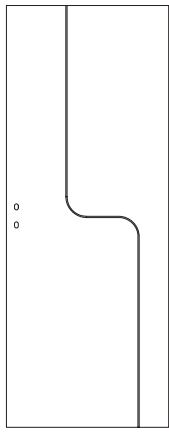

NGL 02

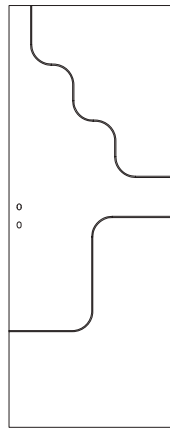

NGL 03

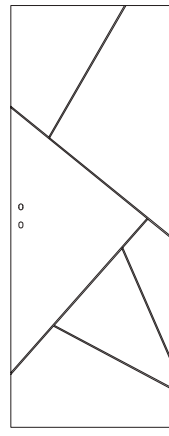

NGL 04

ngl technic

Telaio complanare con cerniere a scomparsa e serratura magnetica.
Inserti in alluminio satinato.
Disponibile anche con cerniera a scomparsa.

serratura magnetica

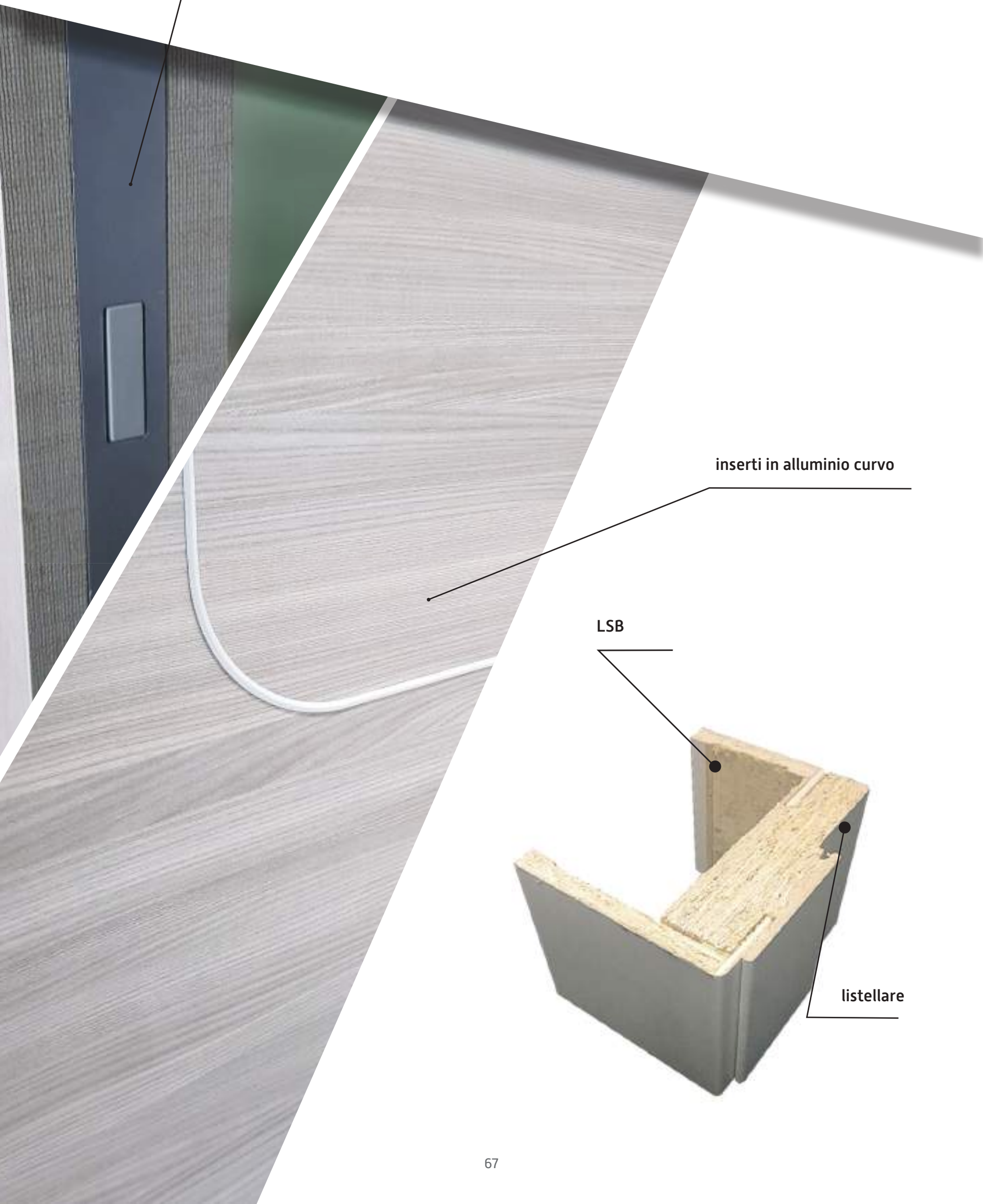

inserti in alluminio curvo

LSB

listellare

IDEAL

Eleganza e linearità

L'intuizione è lineare, pulita, diretta, genera idee. La linea Ideal esprime la visione dinamica del vestire ed interpretare lo spazio. Linee decise, che intrecciano venature e materiali. Essenze pregiate che cedono il passo ad inserti in alluminio o vetro. Superfici pulite che decorano e rifiniscono con garbo gli spazi del vivere quotidiano.







ideal model



ideal 02



ideal 03*



ideal 04



ideal 07V



ideal 08V



ideal 11*



ideal 12

ideal colori



Frassino bianco



Palissandro white



Olmo



Grey



Palissandro blue



Dress Chiaro

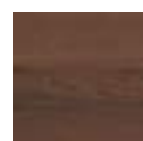

Noce greenwood

*non disponibile nelle essenze Dress chiaro e Grey

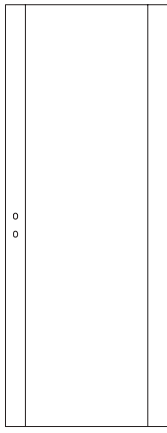

IDEAL 02

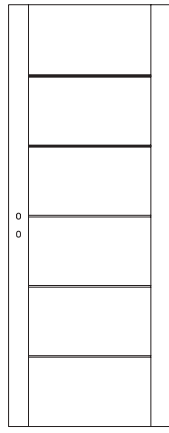

IDEAL 03

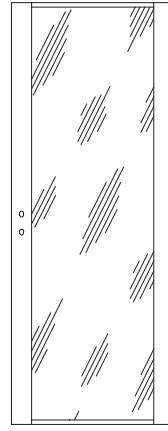

IDEAL 04

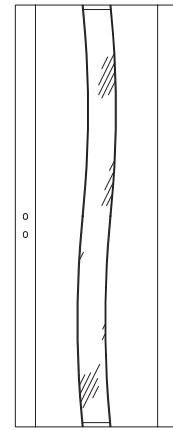

IDEAL 07

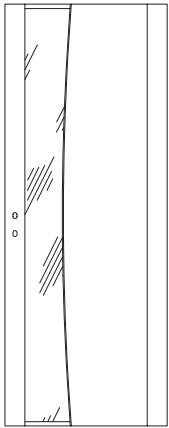

IDEAL 08

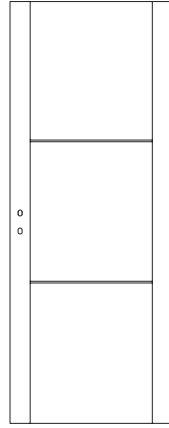

IDEAL 11

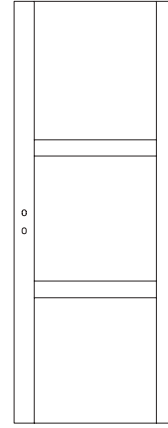

IDEAL 12

ideal technic

Pannello con spessore finito di 44 mm, costituito da supporti in mdf e controplaccato con CPL.

Profili di alluminio incastonati nei modelli illustrati.

Telaio acquarius e cerniere a scomparsa di serie.

serratura magnetica

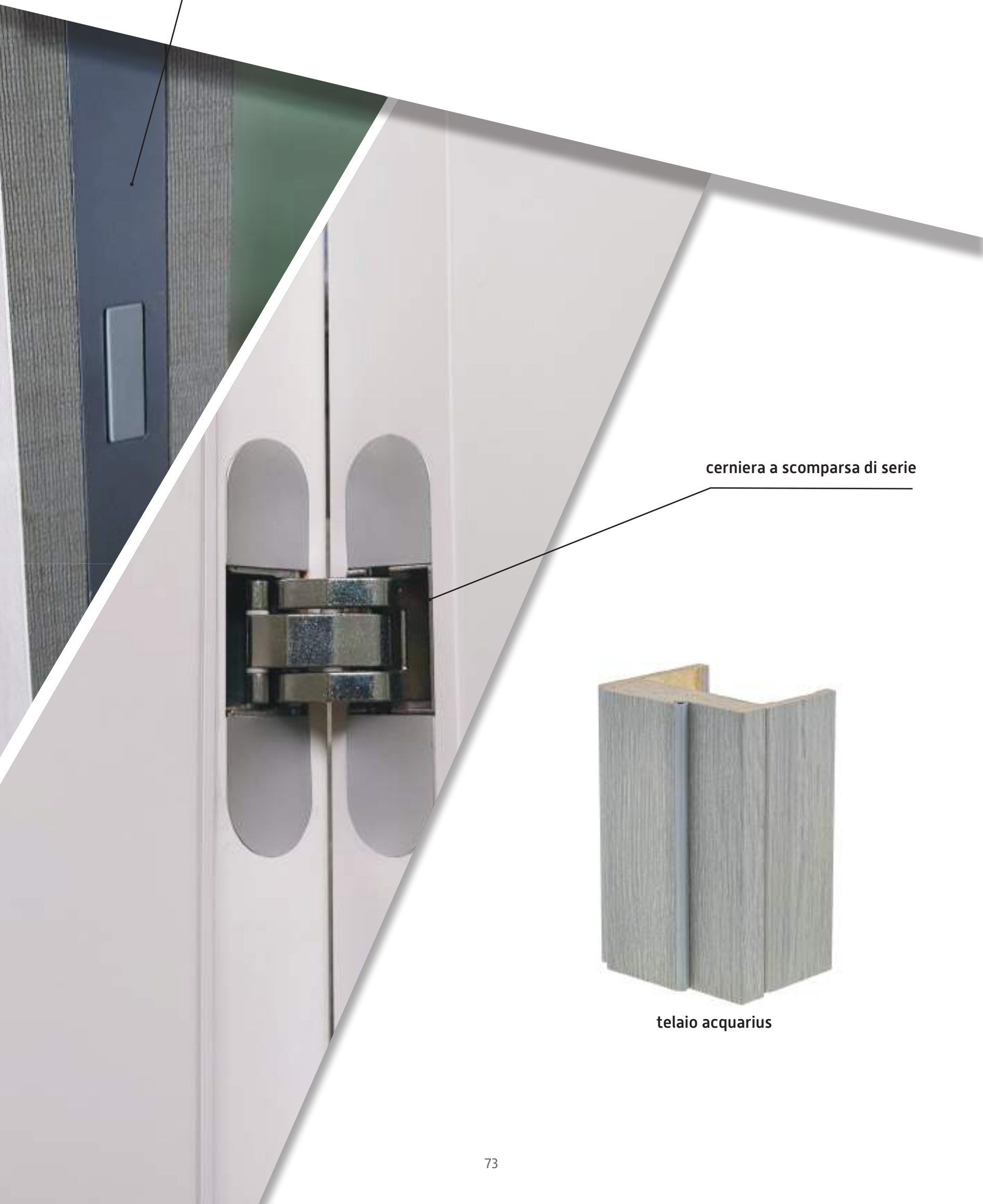

cerniera a scomparsa di serie



telaio acquarius



VISION

bellezza che cattura

La bellezza che cattura lo sguardo, dettagli che passano attraverso gli occhi. Linee in movimento, inserti, incastri, preziose venature.

Tutto in vision esalta le sensazioni di un impatto visivo forte dove le forme si caricano di significati. Dettagli che cambiano, spazi che si personalizzano perché stile è possibilità di rendere unico ciò che si desidera.

Vision: più di quanto immagini.





vision model



vision 01



new vision



vision trend

vision colori



Frassino bianco



Palissandro white



Olmo



Grey



Palissandro blue

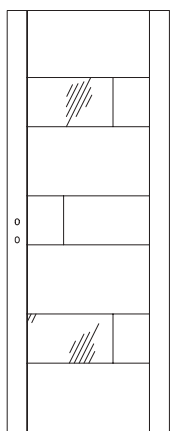

VISION 01

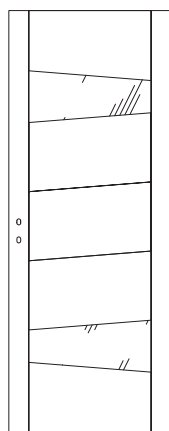

NEW VISION

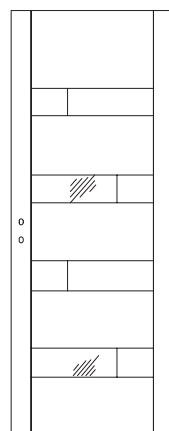

VISION TREND

vision technic

Telaio acquarius di serie. Montanti laterali realizzati in MDF con anima in listellare d'abete.
Stipite con guarnizione in battuta e coprifilo.
Il telaio è predisposto all'uso di coprifili con aletta per compensare meglio i vari spessori muro, le cui forme e dimensioni variano a seconda delle finiture.

cerniera a scomparsa

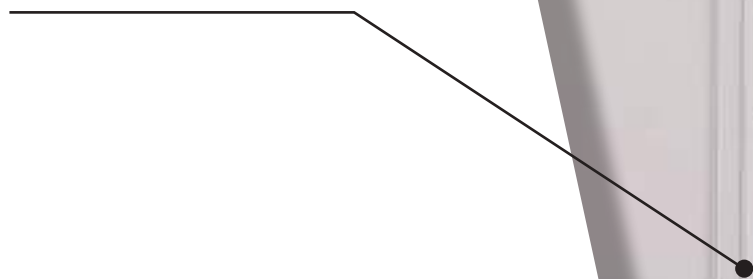

telaio acquarius



INNOVA

Praticità e convenienza

Le porte laminato della linea Innova sono rivestite di un materiale innovativo affidabile e resistente alle sollecitazioni ambientali offrendo, allo stesso tempo un ottimo effetto estetico. Porte pratiche, funzionali e convenienti, che valorizzano i grandi vantaggi del laminato: impermeabilità, resistenza all'umidità. Porte estremamente durevoli e stabili nel tempo.

La gamma di colori delle porte laminate comprende molte essenze, con le varie sfumature, fedelmente riprodotte e cromaticamente resistenti. Una porta moderna, ricercata, dove la semplicità del design esprime la massima eleganza.







innova model



innova nt/cieca

innova nvg

innova linea 1**

innova 01

innova 02



innova 03

innova 04

innova 05

innova 06

innova tt
rovere
sbiancato**

innova tt wengé*

innova colori



ciliegio

noce
nazionale

bianco

rovere
sbiancato

wengé

* I modelli tt sono disponibili solo nelle essenze wengé e rovere sbiancato. Disponibile anche in versione a

** Innova linea 1 non disponibile nelle essenze wengé e rovere sbiancato.

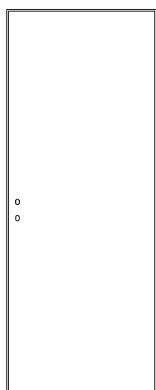

INNOVA NT

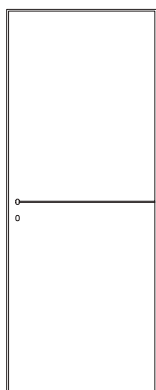

INNOVA 01

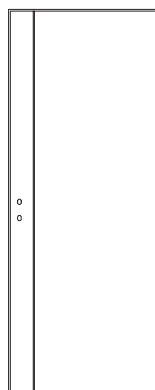

INNOVA 02

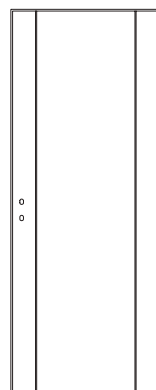

INNOVA 03

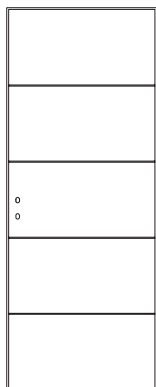

INNOVA 04

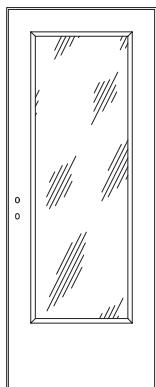

INNOVA NVG

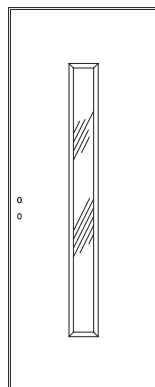

INNOVA LINEA 1

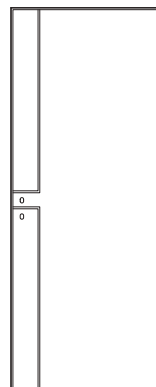

INNOVA 05

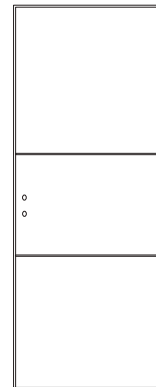

INNOVA 06

innova technic

Materiali
Perimetrale in legno massello
Nido d'ape
Rinforzi serrature
Rivestimento in laminato
MDF



kit telaio e coprifili squadrato (modelli tt)



telaio squadrato, coprifili piatti
per essenze bianco, ciliegio e noce nazionale

REVER

moderna essenzialità

Linee dedicate a chi ricerca in una porta la semplicità del design e l'eleganza dell'essenza, nelle varietà di tutte le sue sfumature. Una porta elegante dalle linee semplici e con un ottimo rapporto tra qualità e prezzo.





rever bianco



rever model



rever 1



rever 2



rever 3

rever colori

rever 1

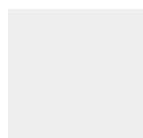

bianco



noce nazionale

rever 2



palissandro white

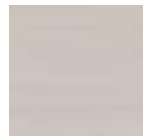

ghiaccio



rovere

rever 3



palissandro white

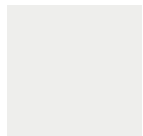

bianco



noce nazionale



bianco matrix

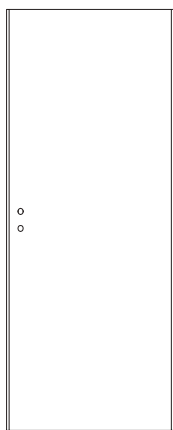

REVER 1

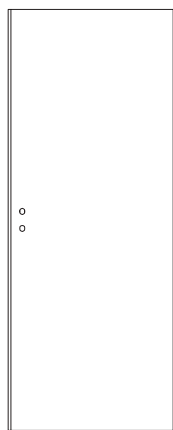

REVER 2

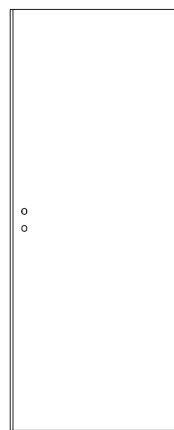

REVER 3

rever technic

rever 1

Di serie con anta reversibile [con battuta], cerniera anuba e serratura mediana cromo satinata.

Telaio squadrato disponibile da 11 cm, con coprifili in mdf da 7 cm.

Disponibile in PRONTA CONSEGNA nelle misure standard a battente [60/70/80/90] e scorrevole a scomparsa 70/80/80.

rever 2

Di serie con anta reversibile [con battuta], cerniera anuba e serratura mediana cromo satinata.

Telaio squadrato da 10 cm, con coprifili piatti ad incastro in mdf da 7 cm.

Disponibile in PRONTA CONSEGNA nelle misure standard a battente [60/70/80/90] e scorrevole a scomparsa 70/80/80.

rever 3

Di serie con anta reversibile [con battuta], cerniera anuba e serratura mediana cromo satinata. Telaio in legno squadrato disponibile da 9,7 cm, con coprifili legno da 7/9 cm.

Disponibile in PRONTA CONSEGNA nelle misure standard a battente [60/70/80/90*] e scorrevoli a scomparsa 60/70/80/90 [con sovrapprezzo].

rever 1 e 2

rever 1 e 2 telaio MDF



rever 3

rever in legno

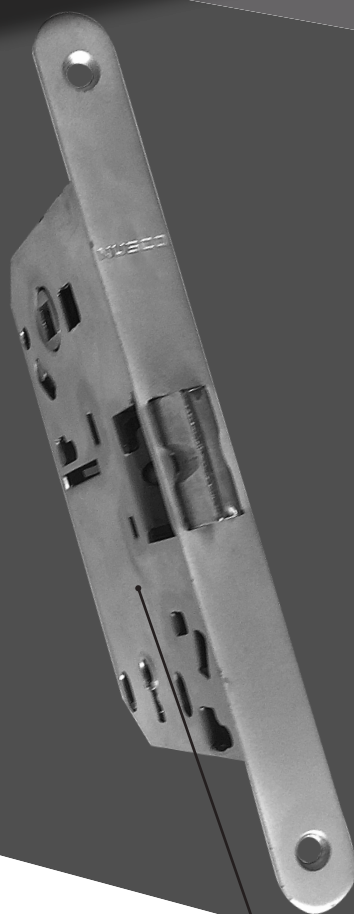

serratura cromo mediana





PLATINUM

Le porte in vero legno massello

Rigore ed originalità, presente e futuro si uniscono armonicamente nella Linea Platinum in Massello, la collezione top di gamma Nusco, che deriva da una tradizione di oltre mezzo secolo nella produzione di porte in vero legno massello. Questa elegante soluzione d'arredo in stile classico fonde con sapienza ed equilibrio la pregiata robustezza del legno con moderne tecniche di produzione e particolari metodi di lavorazione, realizzando un prodotto dal fascino intramontabile e dalle performances d'avanguardia.





platinum model



splendida



galante



pura



vanitosa



passionale



meravigliosa



audace



gioiosa



severa



ovale

platinumcolori

finiture nocino

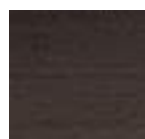

moka

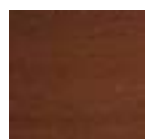

noce scuro

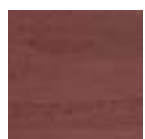

prugna



noce
chiaro



miele

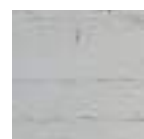

tortora
chiaro



ciliegio



laccato
bianco



noce
antico

finiture rovere

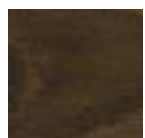

rovere
verde terra



rovere
naturale



tortora
chiaro



mordenzato
bianco

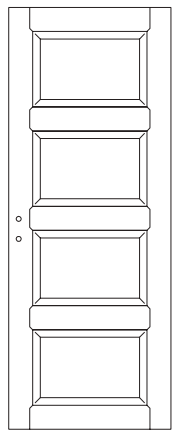

SPLENDIDA

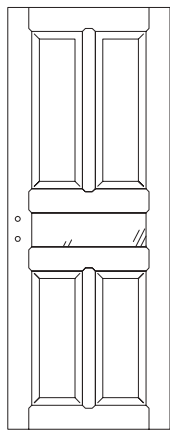

GALANTE

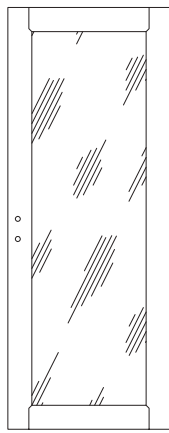

PURA

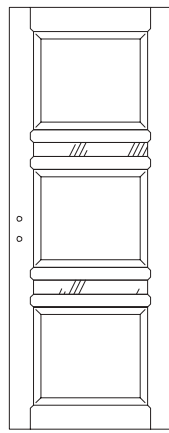

VANITOSA

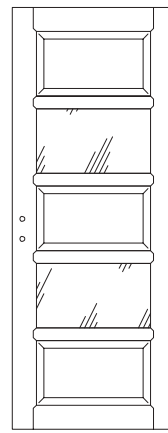

PASSIONALE

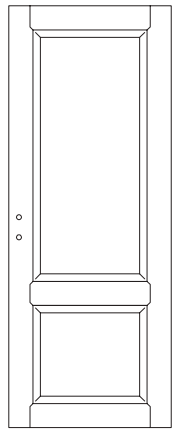

MERAVIGLIOSA

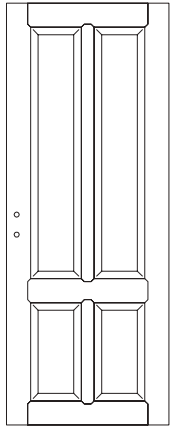

AUDACE

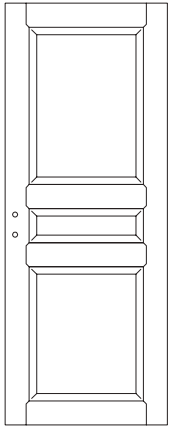

GIOIOSA

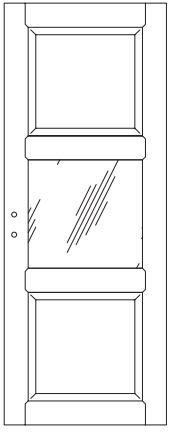

SEVERA

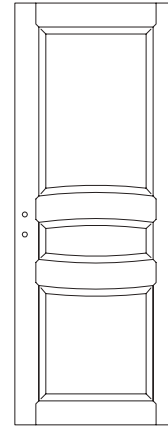

OVALE

platinum technic

Numerose varianti di stile, con la possibilità di scegliere tra le essenze rovere e nocino e diverse tipologie di telaio, coprifili e capitelli.

telaio massello



cerniera a scomparsa



classico



barocco



squadrato



neoclassico

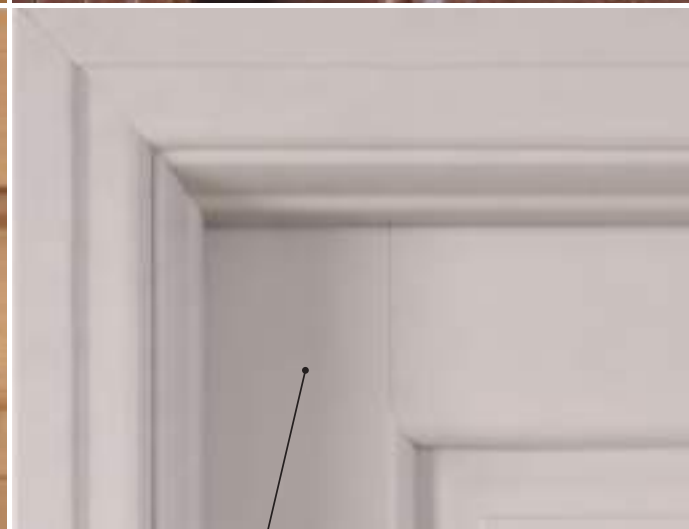



LAVORAZIONI SPECIALI

PIEGO

spazio funzionale

Il sistema Piego di Nusco nasce per abbinare design e funzionalità, nella realizzazione di un elemento di arredo che riesca a risolvere in modo elegante i più comuni problemi di spazio, laddove la porta rappresenti un ostacolo. In particolare, l'innovativo meccanismo del modello "rototraslante" si basa sullo spostamento del perno di rotazione dell'anta, consentendo una notevole riduzione del raggio d'apertura. Disponibile simmetrica e asimmetrica.





ROTOTRASLANTE



Porta complanare

- Realizzabile su modelli color laccato bianco RAL 9003 nt liscia e linea artwork incisa e pantografata.
- Telaio squadrato in listellare
- Coprifilo interno da 70 mm ed esterno da 100 mm
- Cerniere a scomparsa regolabili di serie
- Anta senza battuta e serratura magnetica

complanarità esterna, telaio
e cerniere a scomparsa

dettaglio contropiastra

maniglia minimal

SCORREVOLE MAGIC

La bellezza dell'essenzialità

Design essenziale ed effetto estetico d'impatto per il nuovo kit per porte scorrevoli Magic.







FILOMURO

design e bellezza

La porta filo muro risponde all'esigenza di una porta minimale complanare all'arredo. La filomuro Nusco offre la possibilità di avere l'anta in tinta con la parete ed è anche adatta a risolvere problematiche inerenti a posizionamenti particolari della porta (quali ad esempio sottoscala posizionati all'ingresso delle abitazioni, ripostigli interni o armadi a muro in camere da letto). Originariamente utilizzata per la risoluzione di problematiche estetiche, la porta filomuro oggi viene utilizzata da architetti e interior designer come elemento d'arredo per tutta la casa, grazie alle sue caratteristiche tecniche ed estetiche.





filomuro model



filomuro grezza



filomuro texture

filomuro colori



grezza



frassino
bianco



dress
chiaro



palissandro
white



olmo

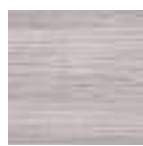

grey



palissandro
blue

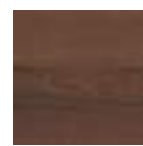

noce
greenwood

Essenza grezza disponibile in PRONTA CONSEGNA, nelle misure standard.
Tempi di consegna altre essenze texture: 20 giorni.



filomuro technic

FILOMURO REVERSIBILE completa di controtelaio, ferramenta standard e serratura magnetica cromo satinato.

Disponibile, con maggiorazione, maniglia ad incasso basculante e chiusura a rullo cromo satinato.

filomuro intonaco

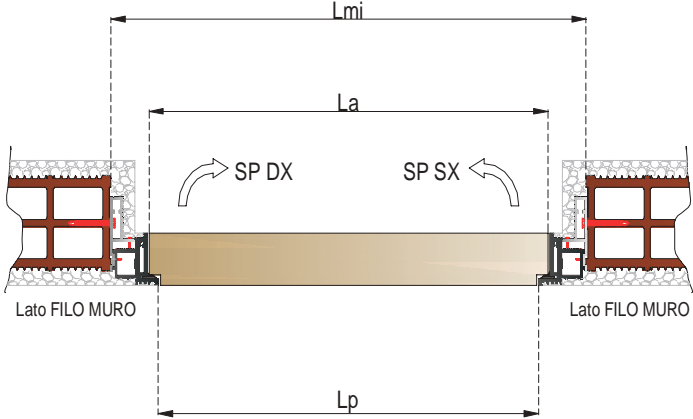
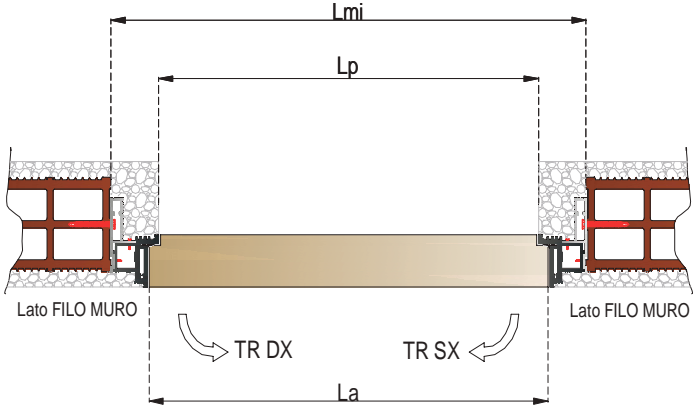
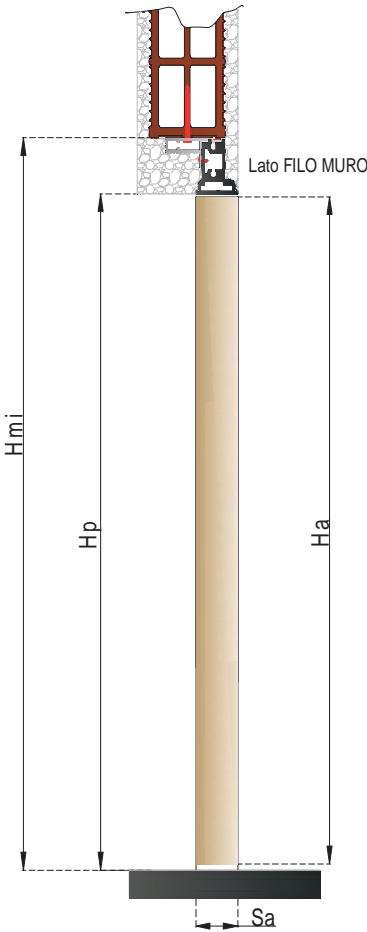

filomuro cartongesso

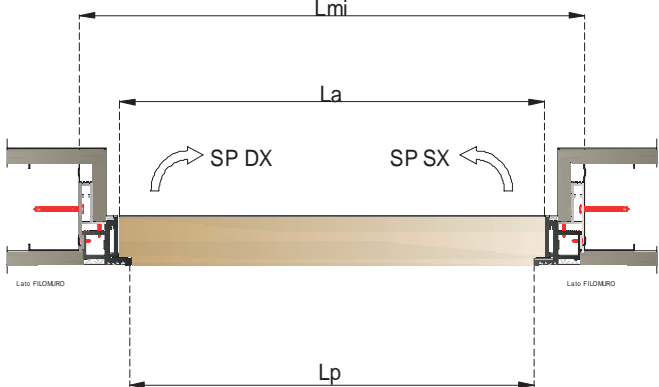
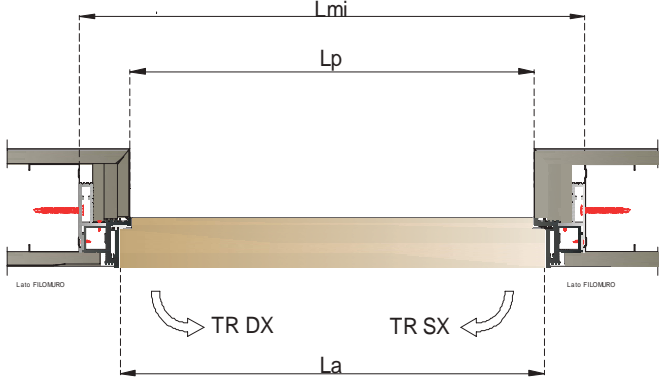
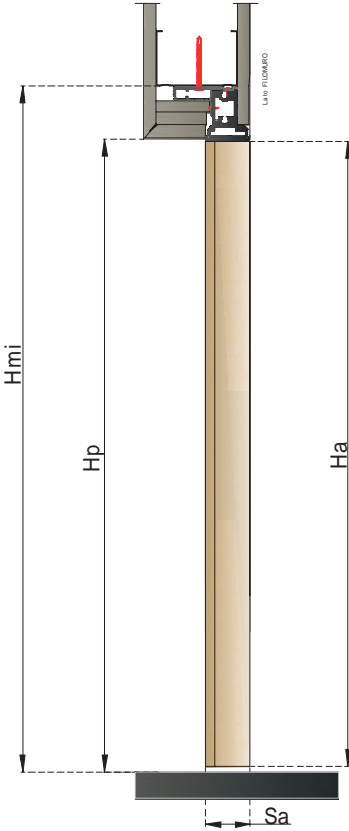

VETRI

Scintillio e magiche rifrazioni

Lo splendore degli Swarovski si sposa alla linearità del vetro. Un gioco di colori e trasparenze rappresentano il valore aggiunto di queste porte con vetri incisi a mano, della nuova Linea Vetri di Nusco SpA. Una grande varietà di temi e accostamenti cromatici esaltano tutti i modelli, sia classici che moderni, design by Matilde Durante. Le fasce in legno incorniciano il cristallo creando un gioco di continuità spaziale con il telaio della porta, sottolineandone la naturale linearità, in un unico insieme armonico.



vetri model



Tribale



Flower 01

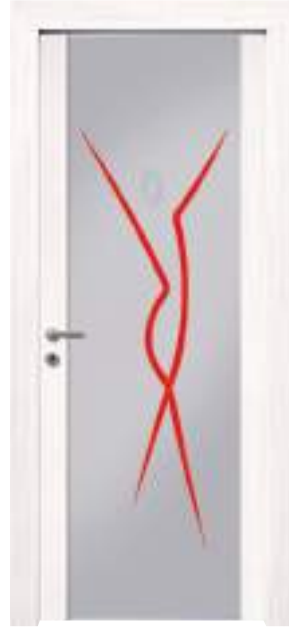

Diana 01



Diana



Style 05



Cielo



Circus



Ovale 01



Flower 02



Ovale 02

Le foto in queste pagine sono state realizzate solo per la visualizzazione dei vetri

vetri model



Ovale 03



Calle 01



Calle 02



Zebrato



Edera



Style 02



Style 02



Style 04



Chrystal



Style 06



Ellisse



MANIGLIE

Le porte Nusco possono essere abbinare a numerose varianti di maniglie dei nostri partner, aziende leader del mercato.

maniglie model



rosita***



quadra***



kit scorrevole linea Modo***
cromo con nottolino

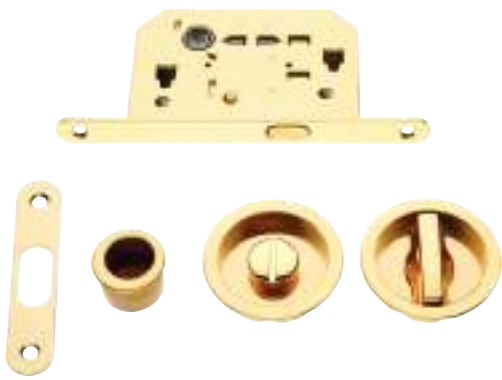

kit scorrevole Nusco
ottone con nottolino



kit scorrevole Nusco
cromo con nottolino



kit scorrevole linea Modo***
cromo-versione con chiave



kit quadro Nusco



minimal



smart



Style

***Disponibile nelle varianti ottone lucido o cromo satinato.

***Le foto sono puramente indicative del modello.



Sistemi ALLUMINIO

Funzionalità,
versatilità e bellezza

Gli spazi domestici del vivere quotidiano e gli ambienti dedicati ogni giorno al lavoro meritano un'attenzione particolare ed un'accurata scelta di forme, materiali e colori. Da questa considerazione prende vita la collezione Luxdoor di Nusco che propone soluzioni d'arredo progettate e realizzate con tecniche innovative, fedeli ai principi di massima funzionalità e precisione.











BLINDATI

sicurezza e solidità

Sicurezza, solidità e qualità sono le caratteristiche non troppo nascoste della linea Blindate.

Design per ogni gusto per il pannello esterno di queste porte dalla comprovata resistenza, che impressionano per la sensazione di sicurezza al primo sguardo.







blindati model



goccia



dune



sole



linear



quadro



artwork 2b



artwork 3b



edge



ring



border



innovative



triangle



linear 3



bubble



fantasy



loop



p1a liscio



lady 1



p1a m



lady 2

blindati colori



Noce medio



Noce per esterno



pantografato noce per esterno



laccato bianco

Altri modelli disponibili da apposito catalogo

blindati technic

Certificazione classe 3 antieffrazione.

Porta di sicurezza mono lamiera, in acciaio zincato, a spingere, ad un'anta con serratura silenziosa a movimento ad ingranaggi composta da un cilindro di sicurezza.

La serratura è protetta da una piastra antitrapano in acciaio sul lato esterno e lo scrocco di chiusura è agevolato da un registro antischeda autoregistrante del battente posizionato sul telaio.

L'anta spessa circa 63 mm è composta da una scatola in acciaio zincato di spessore 9/10 e da tre omega di rinforzo di spessore 9/10.

La scocca è rivestita su entrambi i lati da pannello da 7 mm nelle varianti.

spioncino



cilindro europeo
e ferramenta argento
di serie



Misure disponibili

Luce netta larghezza standard 900/800
Luce netta doppia anta 800+300
Luce netta altezza standard 2100

finestre, persiane e grate



PVC

Prestazioni & design.

Ineguagliabile rapporto qualità prezzo per la linea infissi in pvc Max73 e Power9000.
Isolamento termico e acustico ai massimi livelli.
Valori termici da casa passiva.







pvc model



Pro 72



Power 9000

pvc colori standard power 9000

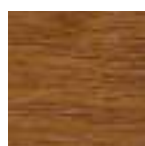

Golden-Oak



Noce



Sheffield
rovere
sbiancato

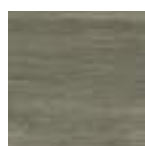

Anteak



Bianco
massa



Bianco
brillante

pvc colori standard pro72

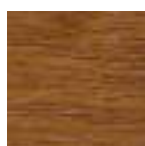

Golden-Oak



Nußbaum 21



White Ash 35

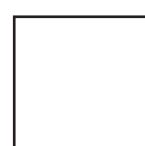

Bianco
massa



Vintage
Oak 41

Altri colori disponibili da mazzetta colori.

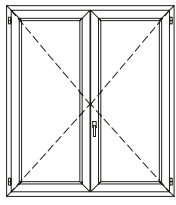

battente

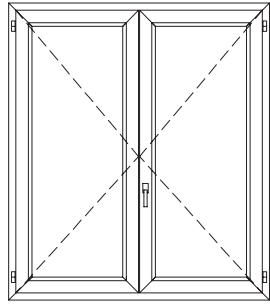

portoncino

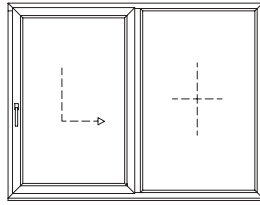

scorrevole
parallelo

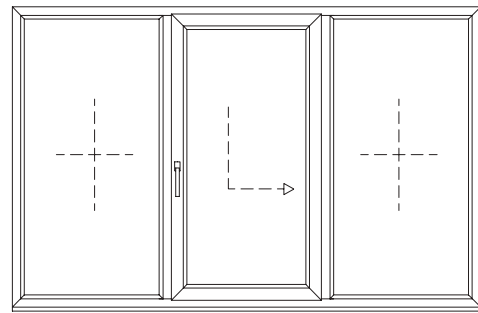

scorrevole
alzante

pvc technic

	PRO 72	Power 9000
sezione telaio	72x70 mm	82,5x70 mm
sezione anta	72x56 mm	82,5x90 mm
camere	5	6
colori di serie		
	Goldeo-Oak 51 Nußbaum 21 Bianco Massa White Ash 35	Golden-Oak Noce Sheffield rovere sbiancato Anteak Bianco Massa Bianco brillante
prestazioni		
trasmissione termica	$U_w = 1,2 \text{ W/m}^2\text{K}$	$U_w = 0,96 \text{ W/m}^2\text{K}$
abbattimento acustico	da 46 db	fino a 46 db
permeabilità all'aria	classe 4	classe 4
tenuta all'acqua	classe 9A	classe 9A
resistenza al vento	classe C5/B5	classe B5
sistema di sicurezza	classe RC2	classe RC2
equipaggiamenti e opzioni*		
apertura anta/ribalta di serie	si	si
telaio ristrutturazione	si	si
asta a leva su finestra 2 ante	si	si
sistemi scorrevoli paralleli	si	si
gas argon vetro camera	di serie	di serie
microventilazione	di serie	di serie
canalina warm edge	di serie	di serie
vetro Saint-gobain PLANITHERM 4S	di serie	di serie
triplo vetro camera	si	si
tipologie speciali (archi, oblò, ecc.)	si	si

ANGOLO PERFETTO NUSCO

Saldatura perfettamente liscia e complanare, che cancella le imperfezioni della saldatura, donando stile e design all'infisso

Resistenza al fuoco categoria 1

100% riciclabilità

Produzione con impiego ottimale delle risorse e scelta accurata dei materiali.

Lavorazione successiva qualitativa attraverso serramentisti qualificati.



Durata, stabilità e sicurezza, elevata nonché estrema semplicità e praticità nell'uso quotidiano.

Smaltimento e riutilizzo del materiale permettono un riciclaggio completo.





LEGNO

Una scelta che premia

Serramenti tecnologicamente avanzati con un'ampia scelta di soluzioni in legno e legno alluminio.





legno model



cosmo 68 massello
listello fisso



cosmo 68 lamellare
con fermavetro

legno colori standard

Pino massello



Noce chiaro

Noce medio

Noce scuro

Ciliegio

Verniciato
bianco

Ontano lamellare



Noce chiaro

Noce medio

Noce scuro

Ciliegio

Wengè

Verniciato
bianco

Altri colori disponibili da mazzetta colori.

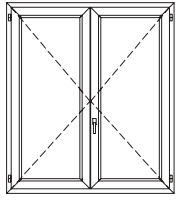

battente

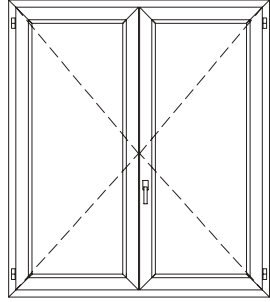

portoncino

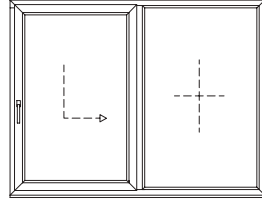

scorrevole
parallelo

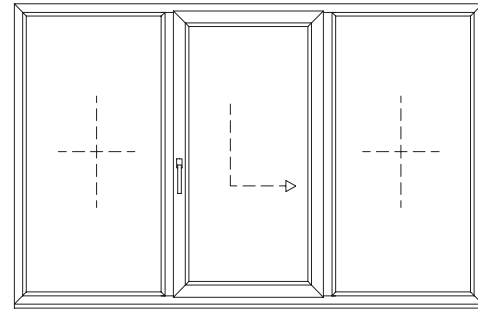

scorrevole
alzante

legno technic

Sez. anta mm. 68 x 77 con listello fermavetro oppure con listello fisso sez. mm. 68 x 80.

Finestra: vetro camera basso emissivo 33.1-18-4 4S BE (sia con listello fisso che con fermavetro).

Portafinestra: vetro camera basso emissivo 33.1-15-33.1 4s BE.

Nella soluzione con listello fisso, nessun traverso intermedio, tre traverse inferiori e vetro camera basso emissivo 33.1-15-33.1 4S BE.

Di serie, anta ribalta in alluminio finitura oro/argento.

Ferramenta a nastro "Maico multi-matic" in acciaio finitura silver con diversi punti di chiusura.

Coprifili solo interni sez. mm. 60x10 arrotondati due lati.

Unione angoli 90°

Cerniera regolabile

Doppia guarnizione



LEGNO/ALLUMINIO

Prestazioni & design.

Serramenti tecnologicamente avanzati con
un'ampia scelta di soluzioni in legno e legno alluminio.







legno/alluminio model



cosmo 68 flat

legno/alluminio colori standard

Colori legno



Noce chiaro

Noce medio

Noce scuro

Ciliegio

Verniciato
bianco

Principali colori alluminio



963S verde
muschio

1013G avorio
groffato

1013S avorio
opaco

7001 grigio

7003 grigio
marmo antico

7200 marrone
marmo

7300 rosso
marmo



8017K
marrone



9010G bianco
groffato



9010K bianco
crema



castano ruvi-
do 375 - 80 R



ciliegio rivido
317 - 70 R



douglas
335 - 80



marrone
ral S8017

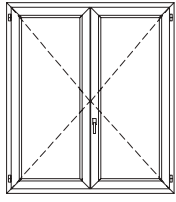

battente

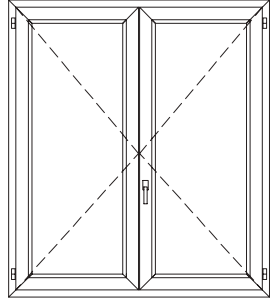

portoncino

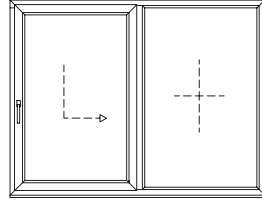

scorrevole
parallelo

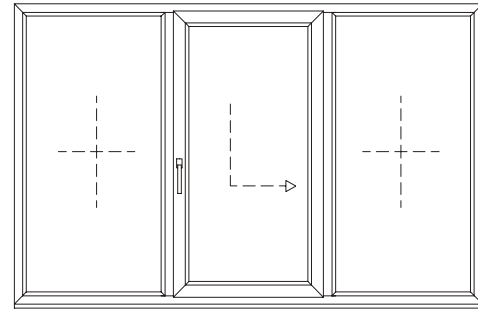

scorrevole
alzante

legno/alluminio technic

Cosmo 68 la

sez. anta mm 85x81

sez. telaio mm 83x90

finestra vetro camera 33.1-18-4 4S BE basso emissivo

Porta finestra vetro camera 33.1-10-33.1 4S BE

Doppia guarnizione termoacustica con ante assemblate a 90°.

Coprifi solo interni sez. mm 60x10 arrotondati su due lati.

Di serie, cerniere di tipo "anuba".

Ferramenta a nastro "Maico multimatic" in acciaio finitura silver con diversi punti di chiusura.

Doppia guarnizione



Vetrocamera Planitherm comfort 4S



sintesy model

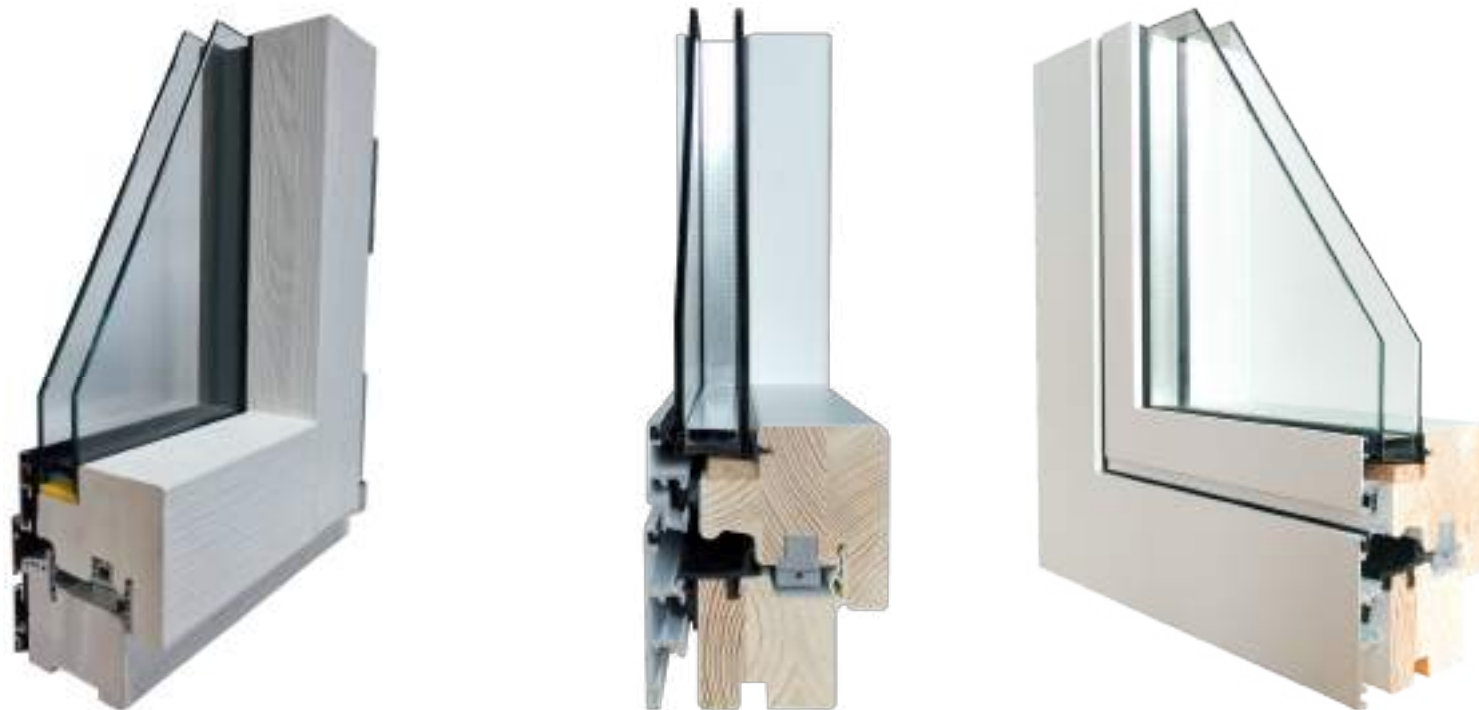

sintesy

sintesy colori standard

Colori legno



total white



frassino white



spazzolato
marrone



tortora



rovere europeo



tabacco

Principali colori alluminio



963S verde
muschio

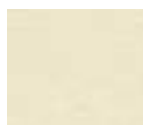

1013G avorio
groffato



1013S avorio
opaco



7001 grigio



7003 grigio
marmo antico



7200 marrone
marmo



7300 rosso
marmo



8017K
marrone



9010G bianco
groffato



9010K bianco
crema



marrone
ral S8017

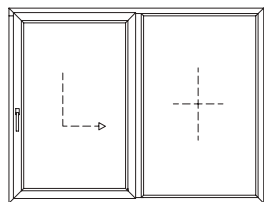
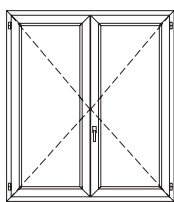

battente

scorrevole
parallelo

sintesy technic

Infissi esterni serie Sintesy W70, in LEGNO LAMELLARE FINGER JOINT, rivestito integralmente con superfici decorative sintetiche ad alta resistenza.

Anta con profilo interno squadrate, profili in alluminio complanari con giunzione ad angoli assemblati meccanicamente.

Finestre costruite con anta assemblata a 90 gradi.

Vetri con gas argon, canalina a bordo caldo di serie.

Cerniere DK con coperture finitura oro e/o argento, martellina DK in alluminio finitura oro e/o argento, ferramenta a nastro "Maico multimatic" in acciaio finitura silver a 3 punti di chiusura con nottolini a fungo già predisposti per soluzione antieffrazione completa

di anta ribalta con aereazione controllata, asta a leva per infissi a doppio battente.

Profili in legno rivestiti integralmente con superfici decorative sintetiche ad alta resistenza abbinabili con numerose essenze delle porte Nusco.



prestazioni legni teneri

Trasmittanza termica $k = 1,2 \text{ W/m}^2 \text{ K}$

Abbattimento acustico 35 db

Permeabilità all'aria classe 4

Tenuta all'acqua classe 9A

Resistenza al vento classe C5

FERRO

Persiane e grate Iron.

La sicurezza Nusco certificata classe 3 antieffrazione. Le persiane e grate Iron sono sinonimo di sicurezza, design e qualità. La ricercatezza estetica e la capacità di adattamento a tutti i contesti urbani rendono le persiane e le grate Nusco ideali per soddisfare ogni tipo di esigenza, in primis per la loro solidità e capacità di resistenza, ma anche per le più semplici funzioni di oscuramento e difesa dalle intemperie esterne.







persiane model



luce 2 small



luce 1 evol



luce 3 large



iron
lamelle fisse



iron orienta

Numerose colorazioni disponibili da catalogo specifico.

grate model

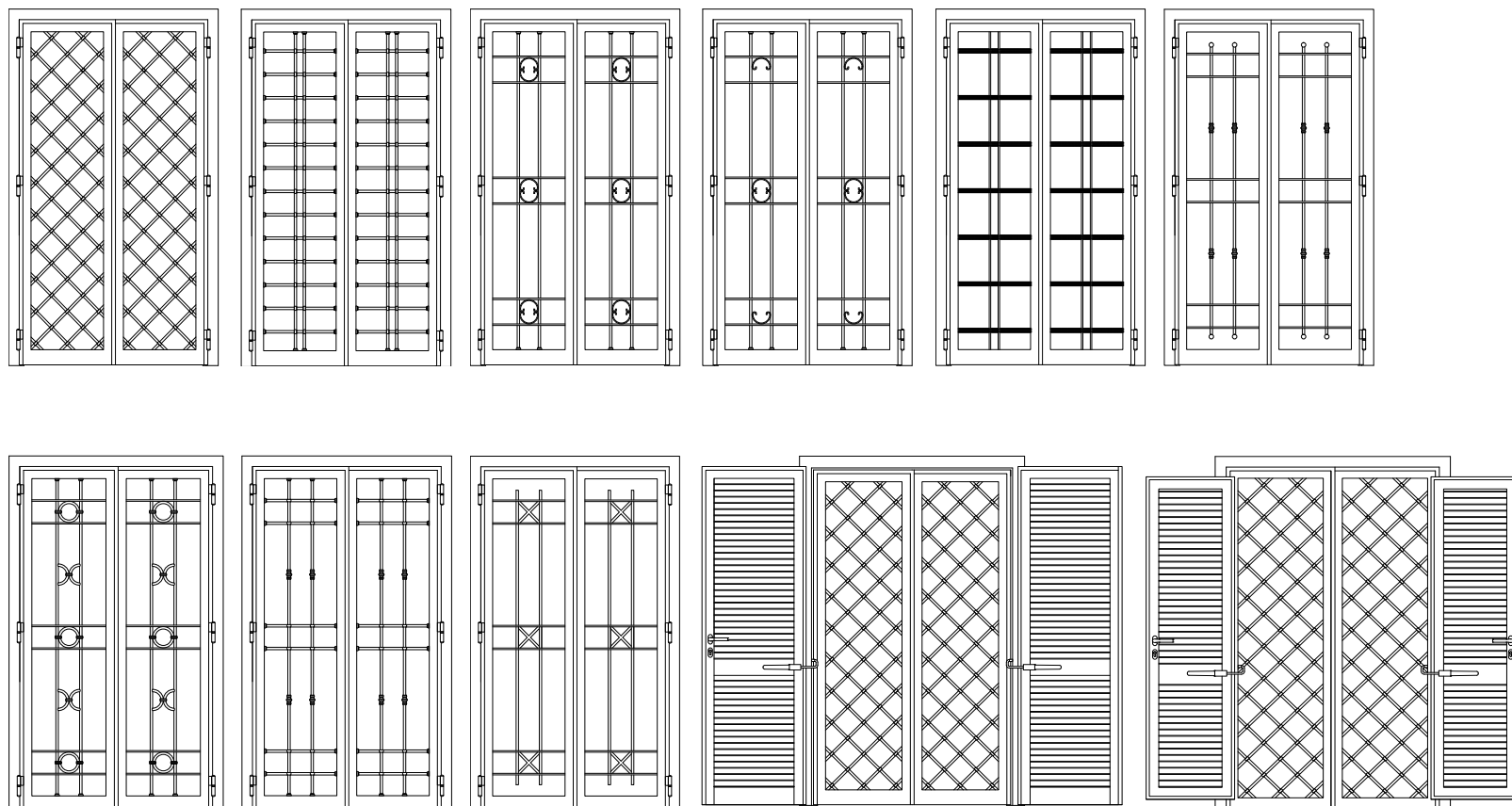

grate technic

Persiane

Battente con lamelle fisse inclinazione a 30° Acciaio zincato a freddo.

Ante realizzate con sezione 40×60 mm spessore 15/10.

Profilo lamella fissa 50×10 sp.12/10 bloccate con sistema antisfilamento a tondino passante 6 mm.

Zoccolo di base di altezza da 105 a 135 in lamiera zincata 15/10.

Telaio fisso a zeta disponibile in due tipologie: LINEAR e BOMBATO.

Cerniere a tappo di diametro 22 mm, altezza 140 mm fornite con perno disponibile anche nella versione con lamelle orientabili.

Grate

Sfilabili e cuscinetto (n°2 per anta sia su finestra che su portafinestra).

N°2 rostri antistrappo per finestra e n°3 per portafinestra, chiusura con serratura a triplice chiusura a bascula, mezzo cilindro europeo con chiave piatta, paletti di chiusura a leva in acciaio zincato.

Maniglie e copricilindro di colore nero di serie Fermapersiana top grillo in nylon.

Lamelle orientabili

classe 3
antiefrazione

Dimensione luce variabile

ALLUMINIO

design e performance

Linee essenziali ma dal design ricercato per la nostra linea di oscuranti in alluminio.

Resistenza, affidabilità e sicurezza, versatilità nelle forme e nello stile, rendono le persiane in alluminio Nusco adattabili ad ogni contesto abitativo.







alluminio model



CX700



CX700 AST



CX700 ASW



CX850



RX450



SX110



HX160

alluminio colori



Ral 1013



Ral 9010



Ral 6005









Ral 8017

Disponibili ulteriori colori standard glitter, ossidati, polvere su polvere, natural e sublimati.
Visionare specifici ca mazzetta colori.

alluminio

technic

	 permeabilità all'aria UNI EN 12207	 permeabilità all'acqua UNI EN 12208	 permeabilità al vento UNI EN 12210	 isolamento termico UNI EN ISO 10077-2	 isolamento termico UNI EN ISO 10077-2	 abbattimento acustico UNI EN ISO 140-3
CX 700	classe 4	classe E 1200	classe C5	1.51/1.15 W/m ² K		fino a 45 dB
CX 700 AST	classe 4	classe E1500	classe C4	1.22/0.80 W/m ² K		fino a 44 dB
CX 700 ASW	classe 4	classe E1500	classe C4	1.25/0.84 W/m ² K		fino a 44 dB
CX 850	classe 4	classe E 1200	classe C5		1.08 W/m ² K	fino a 45 dB
RX 450	classe 3	classe 5A	classe C3			
SX 110	classe 4	classe E900	classe C3		2.0 W/m ² K	fino a 45 dB
HX 110	classe 4	classe 9A	classe C3			



Valori energetici da casa passiva

Uw fino a 0,80 W/m²K

- Ampia disponibilità di colori e tipologie
- Massima adattabilità ad ogni contesto urbano



alluminio persiane model



alluminio persiane colori standard

principali colori alluminio



9635 verde muschio

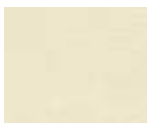

1013G avorio groffato

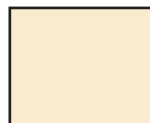

9635 verde muschio



7001 grigio



7003 grigio marmo antico



7200 marrone marmo antico



7300 rosso marmo



8017K marrone

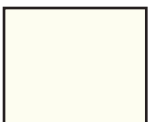

9010G bianco groffato



9010K bianco crema



castano ruvido 375-80 R



ciliegio ruvido 317-70 R



douglas 335-80



marrone ral S8017

PERSIANA OSCURIA
SCORNICIATA (BASE)

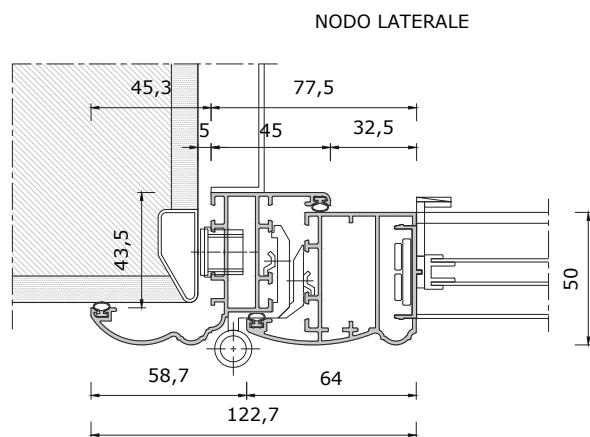

PERSIANA OSCURIA
MODELLO PIATTO

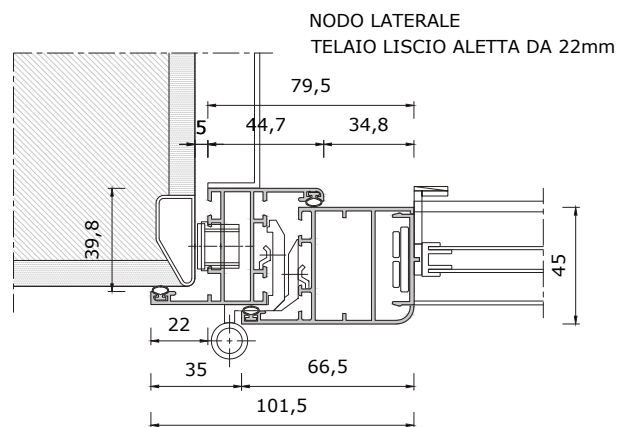

PERSIANA OSCURIA
SCORNICIATA (BASE)

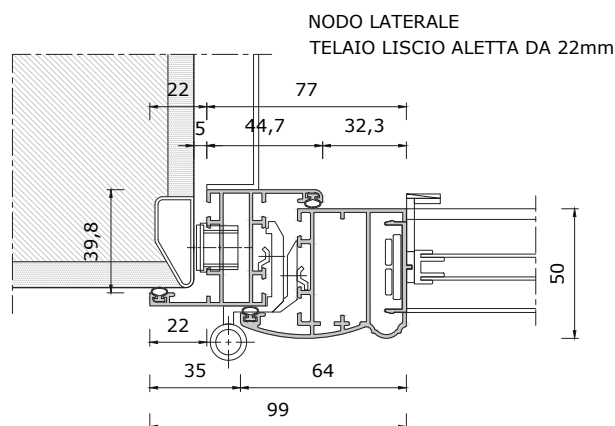

PERSIANA OSCURIA
STORICA

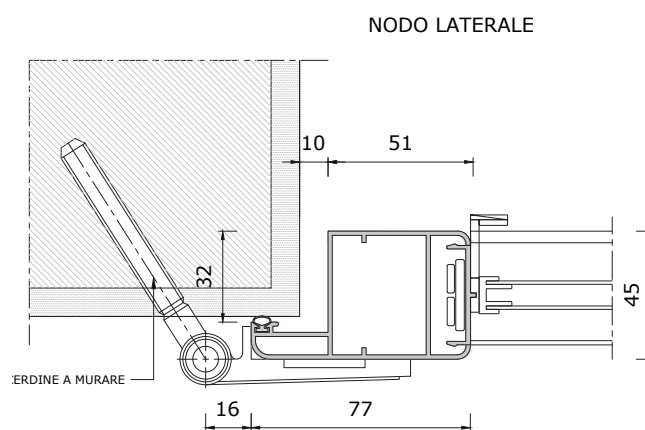

oscuria technic

Oscuria

Persiana battente con lamelle fisse con inclinazione a 30° o orientabili mediante maniglie a leva. Profilati in lega d'alluminio 6060 secondo le normative vigenti.

T5 secondo la norma UNI EN 515 (equivalente TA 16).

Telaio fisso per fissaggio interno 45mm, 80mm con aletta di battuta sagomata.

Anta sezione 50x64 mm [profilo bombato].

Cava per alloggiamento meccanismo 36mm.

Scuretto tra i profilati 5mm.

Cerniere 2 ali, chiusura con cremonese.

A disposizione una vasta gamma di colori: Ral, gotico-groffati, effetto legno.



NUSCO

Sede principale, produzione e store
Nola (NA) - S.S. 7/bis Km. 50.500

Store e franchising

Avellino - Via Giosuè Carducci, 43
Aversa (CE) - Viale della libertà, 28
Battipaglia (SA) - Via Belvedere 142/144
Boscotrecase (NA) - Via Sepolcri, 12
Caivano (NA) - Via S.S. Sannitica, 87 - Km 14.300- 415
Castellammare di Stabia (NA) - via Cavour, 19
Casagiove (CE) - via Appia, 219
Casoria (NA) - s.s. Sannitica, 87 km 7.540
Castel San Giorgio - Via Palmiro Togliatti, 6
Cinisello Balsamo (MI) - via Edmondo De Amicis, 39
Ercolano (NA) - Via S.B. Cozzolino, 110 C
Fondi (LT) - Corso Appio Claudio, 71
Gaeta (LT) - Via Cagliari, 17
Giugliano (NA) - Via Circumvallazione esterna, 143
Mirabella Eclano (AV) - via Nazionale, 51
Mugnano (NA) - Corso Italia, 128
Napoli - Colli Aminei, 130
Napoli - via Cilea, 223
Napoli - Fuorigrotta - via Giulio Cesare, 13-15-17
Napoli - via Salvator Rosa, 249/b
Pianura (NA) - Via Montagna Spaccata, 327
Polla (SA) - via Annia 94B/94A
Pompei (NA) - Via Lepanto, 188
Potenza - c/da Varco D'Izzo
Pozzuoli - Via Raimondo Anncchino, 210
Quarto (NA) - Via Campana, 352
Rimini - Via Marecchiese, 19
Roma - Via di Santa Costanza, 15
Roma - Via dei Prati Fiscali, 150/152
Salerno - via Richard Wagner, 42
San Valentino Torio - Via Orto, 27
Sant'Anastasia (NA) - via Madonna dell'Arco, 225

Sorrento (NA) - viale degli Aranci, 31/G
Torre del Greco (NA) - Corso Avezzano, 49
Torrette di Mercogliano (AV) - via Nazionale, 102
Tufara Valle (AV) - via Appia ss7, 78D
Villaricca (NA) - via Napoli 126
Vitulano (BN) - Strada Provinciale SP109 Via Case Sparse Snc
Volla (NA) - via Luigi Einaudi, 92

nuscospa.com
info@nuscospa.com

